

Throw Distance (Aspect ratio 16:10)

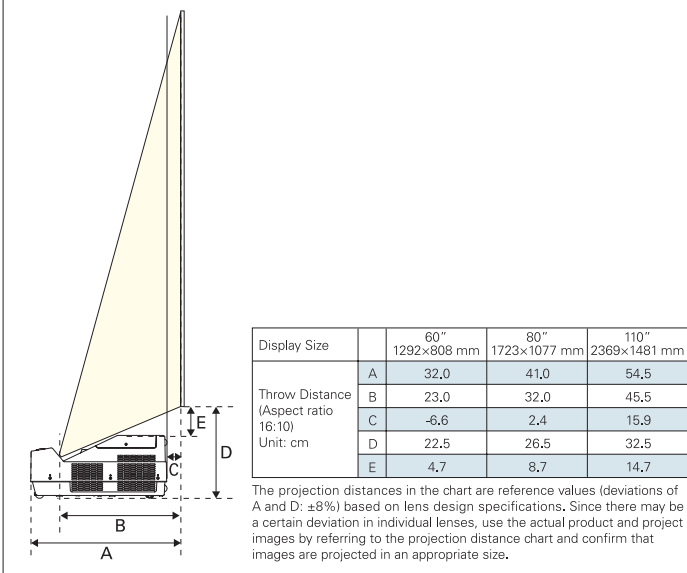

External dimensions (unit: mm (inch))

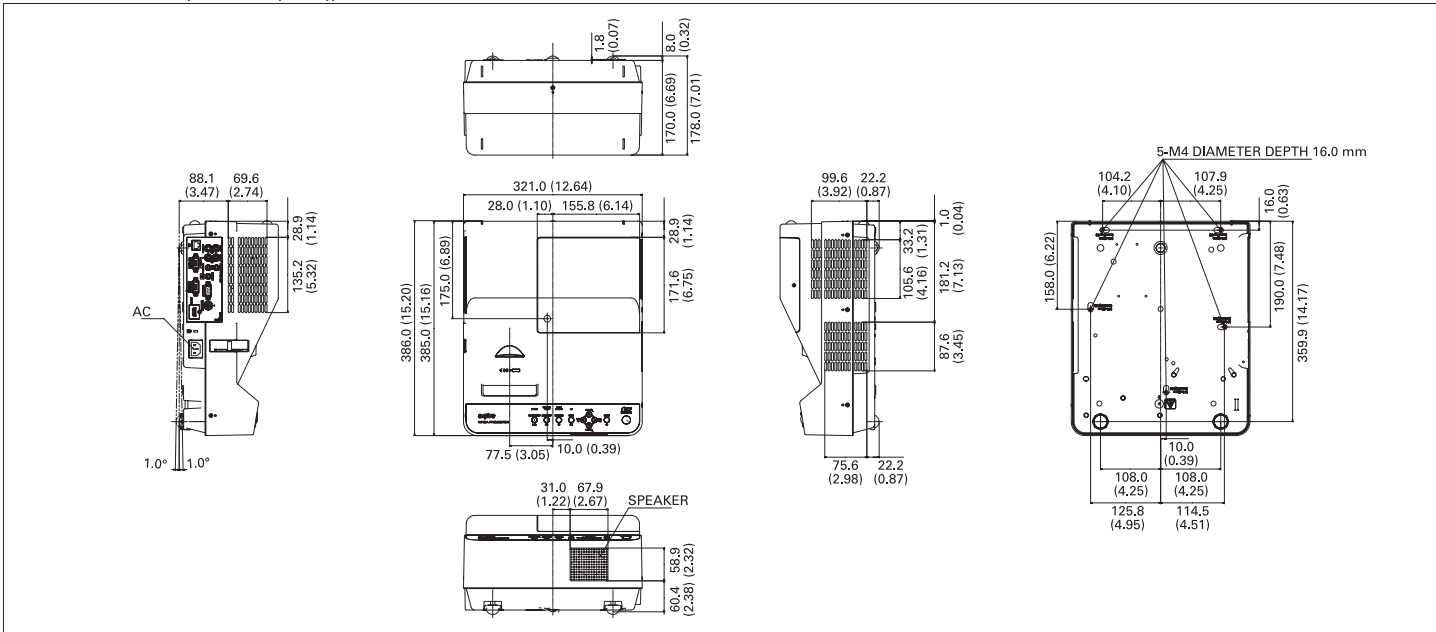

All products manufactured by the Projector Division of SANYO's Digital System Company employ a quality management system that has undergone the inspection and registration process of the ISO 9001 international standard.



SANYO's Digital System Company has received ISO 14001 certification for the environmental management system used in its factory.



<http://sanyo.com/projector/>

Caution: Please consult the instruction manual to ensure safe and proper operation of the product.

Distributed by:

SANYO
SANYO Electric Co., Ltd.
Digital System company

© 2010 SANYO Printed in Japan 2010.6 St. SML161

WXGA
Ultra-Short Focus Projector



PDG-DWL2500

The World's Shortest Focus and a 3D-Ready Design
Expand Projector Possibilities.*



PDG-DWL2500
Brightness of 2,500 lumens



* As of May 18, 2010, for projectors up to 9 kg, Distance from projection window to the screen.

Large 80" image can be projected from the world's shortest projection distance of 32 cm

Projection of a large 80" image at the world's shortest projection distance of about 32 cm (Distance between projector unit and screen surface: 2.4 cm) is achieved by newly developed ultra short-focus mirror projection optical unit. When the distance between projector unit and screen surface is 0 cm, an approximately 74" large image can be projected from a position close to the screen, which allows a presenter to stand in front of the image without casting a shadow on the screen or being bothered by projector light in his or her eyes. This makes it perfect for giving effective lectures or presentations in educational settings. Available maximum projection image size: 110".

Projection comparison with Wall Installation

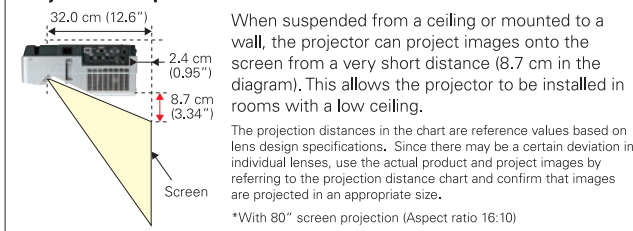

*1 As of May 18, 2010, for projectors up to 9 kg. Distance from projection window to the screen.

Previous model

- When standing in front of a projector, a presenter is dazzled by the light shining.
- A presenter blocks the light and the shadows on the screen disturb the projection.

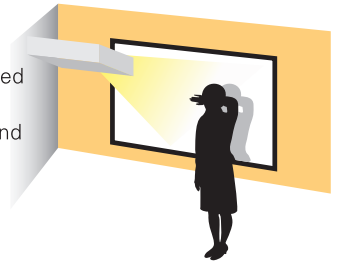

PDG-DWL2500

- A presenter is hardly dazzled even when standing in front of a projector.
- The shadows are hardly cast on the screen.

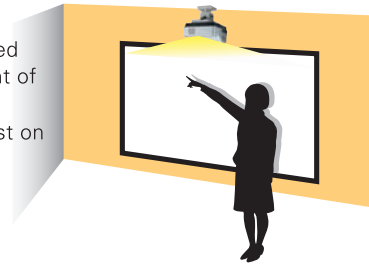

PDG-DWL2500 allowing versatile use, including among others, floor space projection, tabletop projection, and wall-mounted projection

By making use of the main features of the PDG-DWL2500's extremely wide angle and the short distance of projection needed, adding to traditional uses of projectors, many new and various types of applications and locations become available.

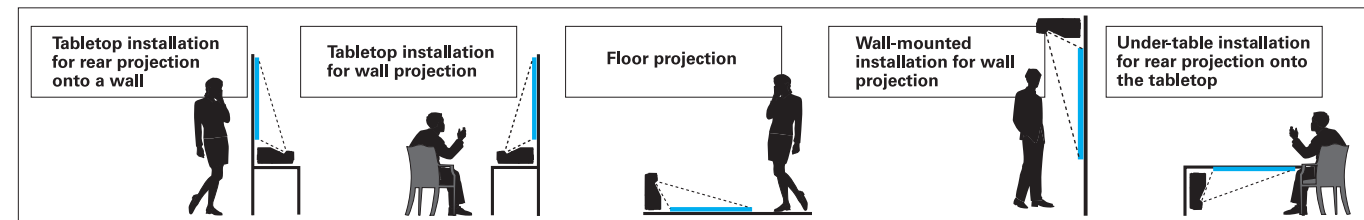

Compact design for saving space of the floor or other installations

Realized a compact projector unit measuring 321.0 mm (width) x 170.0 mm (height) x 385.0 mm (depth), which is about half the size of a conventional model, by the development of a new DLP® format compact optical engine for PDG-DWL2500, and downsizing of the optical components along with the optimization of parts layout. Space saving: PDG-DWL2500 can be installed overhead without looking bulky, or can be installed on the floor without taking up too much space.

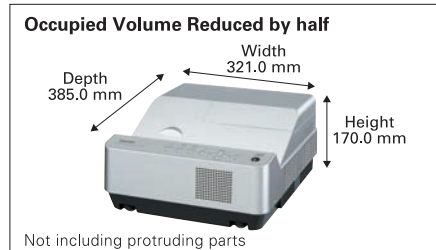

Note: The above is an image only for explanation.

10 W speaker

Along with its mobility, the PDG-DWL2500 features a high-output 10 W speaker that delivers sufficient audio authority for the projector to be used in conference rooms, classrooms, and other spaces without the need for a separate sound system.

Long Life Filter

A metal mesh prevents the entry of large dust particles. The filter itself, which is twice as thick as that of our previous model (the PLC-XL51), concentrates mainly on the air intake section for the lamp to prevent the entry of fine dust particles. This enables an estimated 4,000-hour² filter replacement cycle and reduces maintenance hassles.

*2 Lamp Mode: Eco

Other Feature

- 16:10 wide-screen aspect ratio
- Bright 2500 Lumens³
- High-Contrast 2000:1³
- HDMI Terminal
- Easier Lamp Replacement
- A Wired LAN Network Control Function
- Digital Zoom Function
- Direct ON / OFF Function
- Vertical Keystone Correction (±5 degree)
- Color Board Mode⁴ (Red, Blue, Yellow, Green, Black board)

*3 When Lamp Mode: Normal, and Image Mode: Dynamic are selected.

*4 The colors of images projected onto color board may vary from those of the original input signal.

3D Ready⁵

PDG-DWL2500 have 3D ready⁵, a feature that is rapidly gaining popularity. The "Frame Sequential Display Format"⁶ for 3D technology enables the viewing of 3D images when wearing 3D glasses.

3D presentations in limited spaces are available, thanks to the 3D and short-focus projection technologies.

Corporate customers can use the new products for more realistic and effective presentations, such as 3D product presentations for sales pitches, or design evaluations.

In the entertainment market, the new projectors can be used in various new ways such as the projection of 3D games in an amusement arcade, or the display of a high-impact 3D dinosaur in a natural history museum.

*5 The only compatible 3D image signal is the "Frame Sequential" format. The Frame Packing and Side-by-side formats are not supported. A certain 3D signals are not supported. Please refer to the user's manual for further information. Active Shutter format 3D glasses (sold separately) are required in order to view projected images in 3D.
*6 "Frame Sequential Display Format" is a technology that rapidly alternates between left-eye and right-eye images.

Education

Learning with 3D images much increase student's interest, even some contents that is difficult to understand in 2D! The understanding level and the learning effect improve!



Amusement

It is possible to enjoy playing soccer game by projecting Interactive images on the floor! You can have new experience you have never done!



Museum

With moving dinosaur in 3D, it is possible to have immersive experience as if you are in that era! Visitors would be satisfied a lot!



Business

Showing the owner or prospective buyer rendering in 3D increases reality and persuasion. Moreover, making perspective in 3D eliminates the need for modeling and allows cost reduction!



Note: The above is an image only for explanation.

NVIDIA® 3D Vision™

3D ready for PDG-DWL2500 is compatible with NVIDIA® 3D VISION.

NVIDIA 3D Vision PC supports over 400 existing PC games and keeps increasing in number.

You can easily experience 3D world that will continue to grow such as digital photographs, Blu-ray 3D movies, streamings and videos.



DLP-Link and IR format

PDG-DWL2500 is compatible with the active shutter glasses of both DLP-link and IR format.

DLP-Link

The image involves the synchronized signal and needless to prepare the emitter to watch 3D images.

Required tools: 3D contents + 3D compatible display device + 3D compatible glasses (DLP-Link)

IR format

The projector is mounted with 3D sync out and capable of connecting IR emitter.

Required tools: 3D contents + 3D compatible display device + 3D compatible glasses (IR format) + IR emitter

[Points of Caution When Watching 3D]

3D images should be viewed head-on from a suitable distance (ideally, a distance that is at least three times the height of the image)

The enjoyment of 3D images varies from person to person. In rare cases, individuals may feel unwell while viewing 3D.

If a double image appears when viewing a 3D presentation, or the 3D effect is difficult to see, this may lead to fatigue or a disagreeable feeling.

If you feel unwell while viewing 3D, stop watching immediately. Avoid viewing 3D if you are not in good health.

3D viewing is only recommended for ages 6 and up.

PDG-DWL2500

WXGA | 2500 lm

